



## Cowl Style Hood Scoop

**For proper installation and best possible fit, please read all instructions BEFORE you begin. For technical assistance or to obtain missing parts, please call Customer Relations at 1-800-328-5863.**

### Important Safety Information



- CAUTION - Before driving, ensure that the hood scoops are properly secured to vehicle.
- Do not use automatic "brush-style" car washes.
- Do not use cleaning solvents of any kind.
- Periodically check that all components are secured.

### Contents

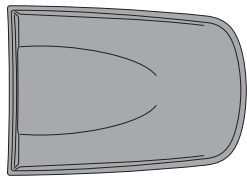

Cowl Hood Scoop



Insert



Alcohol Pad x2

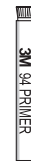

Primer stick x1



Decal x2

### Tools Required



Car Wash Supplies

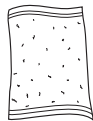

Clean Towel



Masking Tape

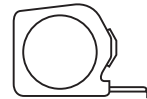

Tape Measure

### Preparation Before Painting / Installation

- A trial fit is recommended to ensure proper positioning and fit.
- Check fit of parts before painting as we will not accept the return of modified or painted parts.
- Wash your vehicle's hood to remove any debris and/or dirt.
- Dry the hood with a clean towel.

### Installation Steps

**NOTE:** Actual application may vary slightly from illustrations.

Remove adhesive liner from insert, and affix to hood scoop.

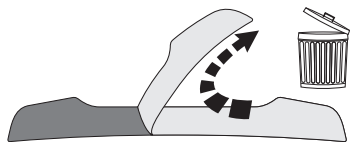

1

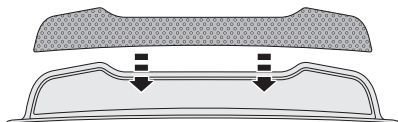

Center part on hood, and mark edges for reference with masking tape.

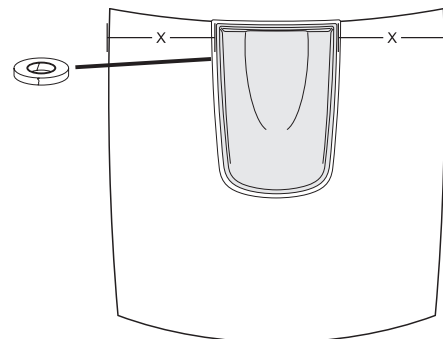

2

# Installation Steps

**NOTE:** Actual application may vary slightly from illustrations.



Clean hood scoop mounting location with alcohol pad.



masking tape

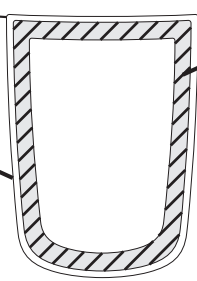

3



**CAUTION: Read surface prep warning on page 1 before continuing.**

Apply primer stick to the hood's surface, inside of the masking tape.

masking tape

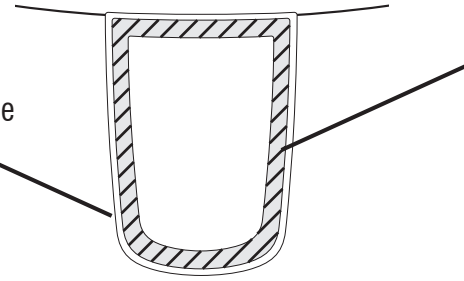

4

Peel back 2" of tape liner from each end of flange of hood scoop.

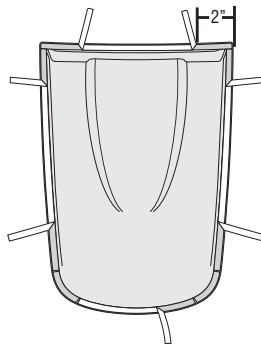

5

Position scoop on hood and apply pressure to exposed tape. In its final position, remove remaining tape by pulling on free ends.

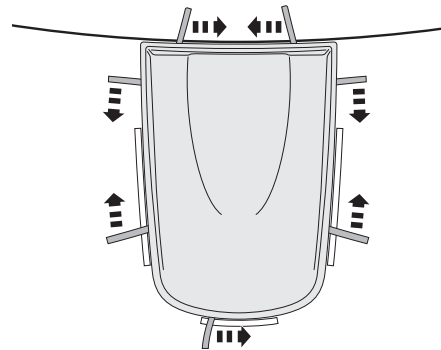

6

Apply pressure to all edges to ensure adhesion.

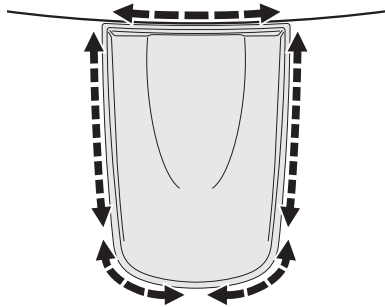

7



Adhere decal to side of hood scoop.

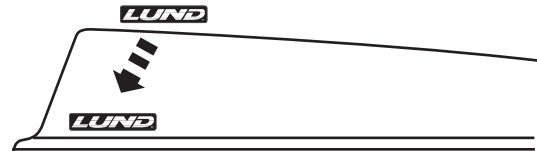

8

## Care and Cleaning

- Wash only with mild soap & dry with a clean cloth.

## Congratulations!

You have purchased one of the many quality Lund™ branded products offered by Lund International, Inc. We take the utmost pride in our products and want you to enjoy years of satisfaction from your investment. We have made every effort to ensure that your product is top quality in terms of fit, durability, finish and ease of installation.



Lund International, Lund Accessories Division  
300 Horizon Drive, Suwanee, GA 30024

800-328-5863 • Visit us at [lundinternational.com](http://lundinternational.com)  
© 2005 Lund International, Inc. All rights reserved.

Lund™ and the Lund™ logo are trademarks of Lund International, Inc.





## Air Du Capot

Pour obtenir une installation correcte et le meilleur ajustement possible, lire toutes les instructions **AVANT** de commencer.  
 Pour toute assistance technique ou obtention de pièces manquantes, appeler le service des relations avec la clientèle au 1-800-328-5863

### Informations importantes concernant la sécurité



- ATTENTION – Avant de conduire, s'assurer que la Godet De Capot est solidement assujettie sur le véhicule.
- Ne pas utiliser les stations de lavage de voitures à brosses.
- Ne pas utiliser de solvants.
- Vérifier régulièrement le serrage des composants.

### Contenu

**NOTE:** Le produit réel peut changer de l'illustration.

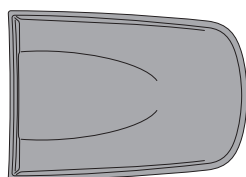

air du capot



Insertion



Tampons à l'alcool (2)

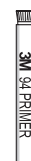

bâton adhésif  
(1)



Décalque (2)

### Outils nécessaires



Fournitures pour lavage de voiture



Serviette propre



du ruban-cache



Mesure De Bande

### Préparation pour la peinture/l'installation

- Il est recommandé de procéder à un essai pour s'assurer que le positionnement et l'ajustement sont corrects.
- Vérifier l'ajustement des pièces avant peinture, car nous n'acceptons pas le retour de pièces modifiées ou peintes.
- Lavez le capot de votre véhicule pour enlever n'importe quels débris et/ou saleté.
- Séchez le capot avec une serviette propre.

### Étapes d'installation

**REMARQUE :** La méthode d'application peut être légèrement différente de celle représentée par les illustrations.

Enlevez le recouvrement adhésif de l'insertion, et l'afix sur le godet de capot.

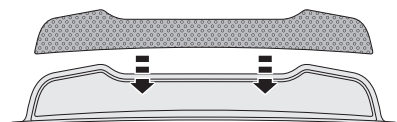
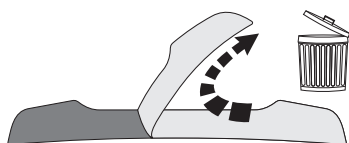

1



Centrer la pièce sur le capot et en marquer les rebords avec du ruban-cache, pour référence ultérieure.

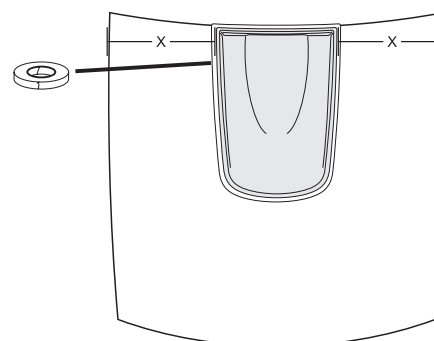

2

## Étapes d'installation

REMARQUE : La méthode d'application peut être légèrement différente de celle représentée par les illustrations.

Alcohol Pad

Nettoyez l'endroit de support de godet de capot avec la garniture d'alcool.

du ruban-cache

Alcohol Pad

3

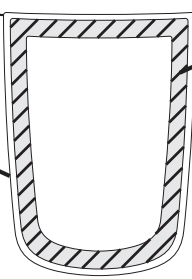

**ATTENTION: Lisez l'avertissement de préparation extérieure à la page 1 avant de continuer.**

Appliquez-vous le promotor adhésif à la surface du capot, à l'intérieur de du ruban.

du ruban-cache

4

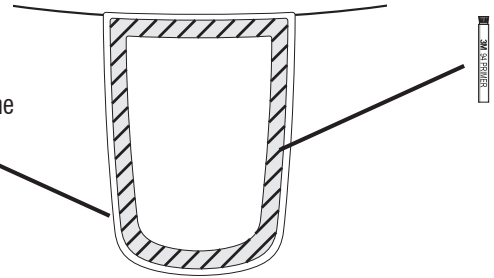

Découper 5 cm (2 po) de protection d'adhésif à chaque extrémité du rebord avant.

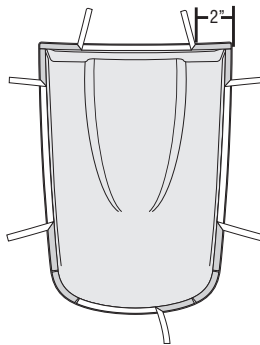

5

Mettez la prise d'air en place sur le capot et appuyer sur le ruban adhésif exposé. Une fois la prise d'air en position finale, retirer le reste du ruban adhésif en tirant sur ses extrémités libres.

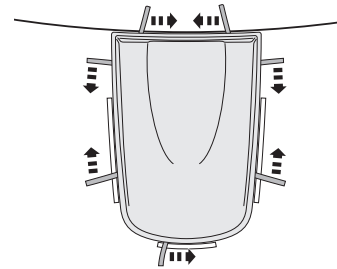

6

Appuyer sur tous les rebords pour assurer une bonne adhésion.

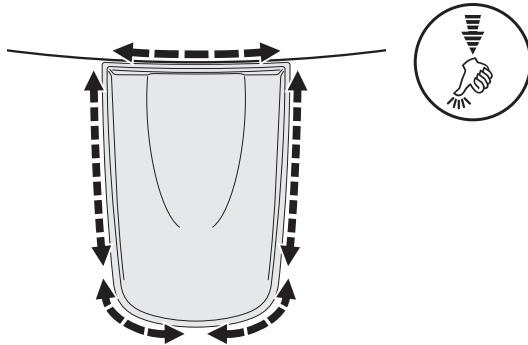

7

LUND

Adhérez le décalque au côté du godet de capot.



8

## Entretien et nettoyage

- Laver exclusivement avec de l'eau savonneuse et sécher avec un chiffon propre.

## Félicitations !

Vous avez acheté l'un des nombreux produits de qualité Lund™ fabriqués par Lund International, Inc. Nous sommes extrêmement fiers de nos produits et souhaitons que vous tiriez des années de satisfaction de votre investissement. Nous avons pris toutes les mesures nécessaires pour assurer que ce produit est d'une qualité supérieure en ce qui concerne l'ajustement, la durabilité, la finition et la facilité d'installation.

**LUND**

Lund International, Lund Accessories Division  
300 Horizon Drive, Suwanee, GA 30024  
800-328-5863 • Visitez notre site [lundinternational.com](http://lundinternational.com)

© 2005 Lund International, Inc. Tous droits réservés.

Lund™, le logo Auto Ventshade™ et le logo Lund™ sont des marques déposées de Lund International, Inc.





## Aire Del Capó

Para una instalación adecuada y el mejor ajuste posible, lea todas las instrucciones ANTES de comenzar. Si desea recibir asistencia técnica u obtener piezas faltantes, llame al Servicio al cliente al 1-800-328-5863.

### Información importante de seguridad



- PRECAUCIÓN - Antes de conducir, asegúrese de que la aire del capó esté correctamente anclada al vehículo.
- No utilice servicios automáticos de limpieza de vehículos que utilizan cepillos.
- No utilice limpiadores al solvente de ningún tipo.
- Compruebe periódicamente que todos los componentes estén ajustados.

### Contenido

NOTA: El producto real puede variar de la ilustración.

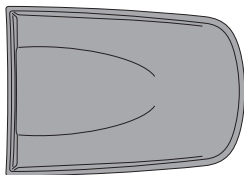

aire del capó



pantalla



Paños esterilizados (2)

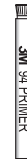

palillo adhesivo  
(1)



Etiqueta x2

### Herramientas necesarias



Equipo de limpieza de vehículos

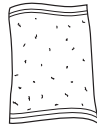

Toalla limpia



cinta adhesiva

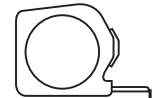

Cinta métrica

### Preparación antes de pintar o instalar

- Se recomienda realizar un ajuste de prueba para asegurar el posicionamiento y ajuste correctos.
- Compruebe que las piezas se ajusten correctamente antes de pintarlas, ya que no aceptaremos la devolución de piezas modificadas o pintadas.
- Lave la capilla de su vehículo para quitar cualquier ruina y/o suciedad.
- Seque la capilla con una toalla limpia.

### Installation Steps

NOTE: Actual application may vary slightly from illustrations.

Quite el trazador de líneas adhesivo del relleno, y el afij a la cucharada de la capilla.

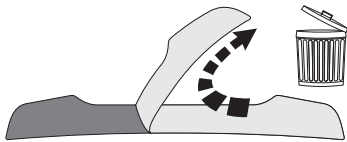

1

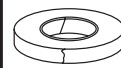
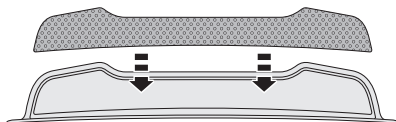

Centre la pieza sobre el capó y marque los bordes con cinta adhesiva como referencia.

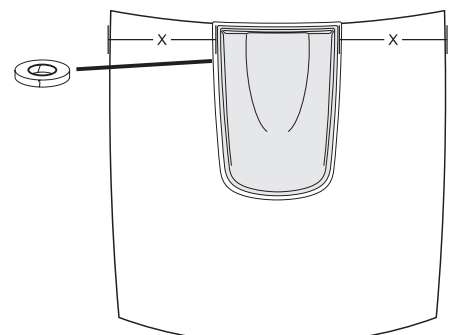

2

## Pasos de instalación

**AVISO:** La colocación real puede variar con respecto a las ilustraciones.

Alcohol Pad

Limpie la superficie pintada del capó donde se colocará la entrada de aire con un paño esterilizado.

Alcohol Pad

cinta adhesiva

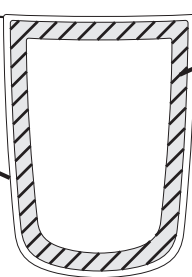

3

**PRECAUCIÓN:** Lea la advertencia de la preparación superficial en la página 1 antes de continuar.

Aplice el promotor adhesivo a la superficie de la capilla, dentro de la cinta que enmascara.

cinta adhesiva

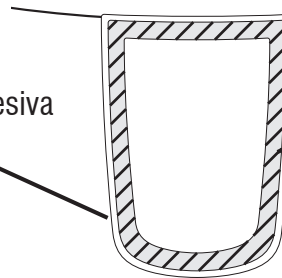

4

Retire 2 pulgs. (5 cm) de cinta protectora de cada uno de los extremos del reborde frontal.

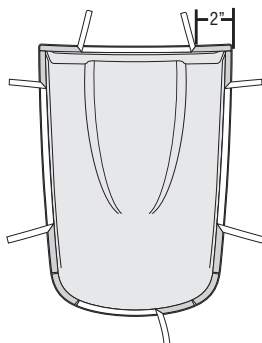

5

Coloque la entrada de aire sobre el capó y presione la cinta expuesta. Una vez que se encuentra en su posición definitiva, quite la cinta adhesiva restante tirando de los extremos libres.

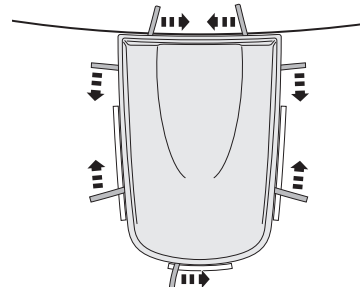

6

Presione todos los bordes para fijarla.

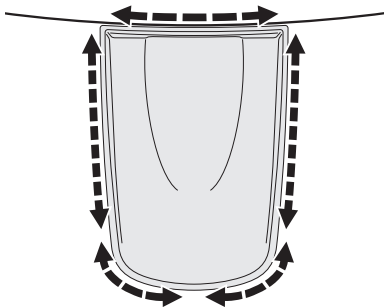

7

Adhiera la etiqueta al lado de la cucharada de la capilla.



8

## Cuidado y limpieza

- Limpie solamente con agua jabonosa tibia y seque con un paño limpio.

## Felicidades

Usted ha comprado uno de los tantos artículos de calidad de Lund™ ofrecidos por Lund International, Inc. Nuestros productos son nuestro mayor orgullo. Deseamos que disfrute de años de satisfacción con su inversión. Hemos realizado todos los esfuerzos para asegurarnos de que su producto sea de la mejor calidad en cuanto a ajuste, durabilidad, acabado y facilidad de instalación.

**LUND**

Lund International, Lund Accessories Division  
300 Horizon Drive, Suwanee, GA 30024

800-328-5863 • Visite nuestro sitio Web: [lundinternational.com](http://lundinternational.com)

© 2005 Lund International, Inc. Todos los derechos reservados.

Lund™, el logo de Auto Ventshade™ y el logo de Lund™ son marcas comerciales de Lund International, Inc.

**LUND**  
INTERNATIONAL